

Aristel Networks

User Manual for the AN208



2 Line / 9 Handset Telephone System

Aristel Networks Pty Ltd

Unit 1, 25 Howleys Road

Notting Hill. Victoria. 3168

Telephone: 03 8542 2300

Facsimile: 03 9544 3299

TABLE OF CONTENTS

1. GENERAL.....	1
2. INSTALLATION	1
2.1. Charger.....	1
2.2. Batteries in Handset.....	1
2.3. Base Station Rear.....	2
2.4. Handset Controls.....	2
2.5. Handset Key / LCD displays brief overview :.....	3
2.6. Using the Menu:.....	3
2.7. Handset Display Language	3
3. GETTING STARTED.....	4
3.1. Ringing Priority	4
3.2. Line Priority For Handsets.....	5
3.3. Handset Group	5
4. HANDSET OPERATION.....	6
4.1. Switching the Handset On / Off.....	6
4.2. Making an external call.....	6
4.3. Making an Internal Call	7
4.4. Answering an Incoming Phone Call	7
4.5. Changing the Speaker Volume.....	8
4.6. Deactivating the Microphone (Mute)	8
4.7. Last Number Redial	8
4.8. Calling a Number Out of the Caller List.....	8
5. Call Transfer, On Hold, Toggle and Three Party Conference.....	9
5.1. Call on Hold.....	9
5.2. Transfer External Call to Another Handset.....	9
5.3. Alternate Call	9
5.4. Three Party Conference Call.....	9
5.5. Handling Two External Calls Simultaneously Using One Handset.....	10
6. PHONEBOOK.....	10
6.1. Using the Alphanumerical Keypad	10
6.3. Changing a Number and/or Name in Phonebook	11
6.4 Reading the Phonebook List	12
6.5. Erasing One Number and/or Name from the Phonebook	12
6.6. Erasing All Numbers and/or Names from the Phonebook.....	12
7. HANDSET SETTINGS	13
7.1. Key Lock.....	13
7.2. Selecting the Ringer Melody and Volume for External Calls.....	13

7.3. Selecting the Ringer Melody and Volume for Internal Calls	13
7.4. HOT CALL/Baby Call Function	14
7.5. Enable/Disable Key Tone.....	14
7.6. Naming a Handset.....	15
7.7. Set PIN Code	15
7.8. Auto PICKUP On/Off	16
7.9. To Answer Call Using Anykey	16
7.10. Erase Caller List.....	16
7.11. Handset Reset.....	17
8. Subscribe / Unsubscribe a Handset.....	17
8.1. Subscribe a handset to the DECT system	17
8.2. Remove Subscription of a Handset from the DECT system.....	19
8.3. To Change the Previously Assigned Handset No.	20
8.4. Selecting a Base Station.....	20
9. BASE SETTINGS	20
9.1. Dialing Mode	20
9.2. Set Recall/Flash Time	20
9.3. To Set Pause Time.....	21
9.4. Call Barring.....	21
9.5. Least Cost Route	22
9.6. Change PIN Code	23
9.7 Reset Base Station Settings.....	23
10. TECHNICAL DATA.....	24

1. GENERAL

This is a Two Analogue Line DECT System which utilizes all the services that are offered by the Analogue (PSTN) network.

You can subscribe up to 9 handsets on this DECT System Base station and every handset can be subscribed on 4 different base stations. (Maximum number of extensions can be extended to 15)

Other brand handsets may also be subscribed to this DECT System station, if they support the GAP standard.

Important note: not all the functions of this DECT System can be used if you use a handset other than the Aristel DECT System handset. To have the best performance from this DECT System, we recommend using only the Aristel DECT System handsets.

2. INSTALLATION

2.1. Charger

Before you use the telephone for the first time, you must make sure the batteries are charged for 15 hours. If you don't do this, the telephone may not function to its full range potential.

Installation of the charger:

- Plug one end of the adapter into a power outlet and the other end into the adapter jack on the side of the charger.

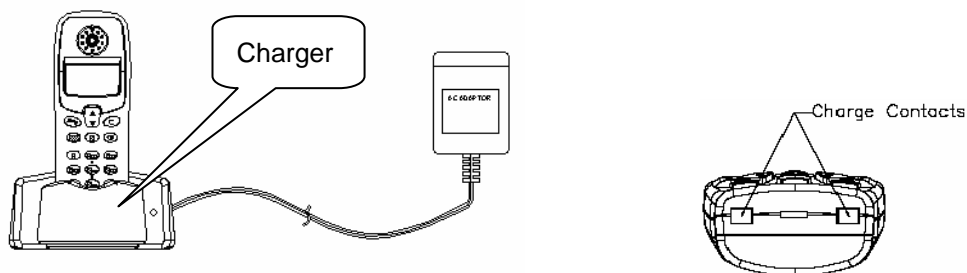

2.2. Batteries in Handset

- Open the battery compartment
- Put the 3 rechargeable batteries (AAA, 550mA) in the battery compartment
- Close the battery compartment.
- For the initial charge, leave the handset on the charger for a minimum of 15 hours.

Battery indicator:

- The battery is fully charged.
- The battery is $\frac{3}{4}$ charged (75%)
- The battery is 50% charged.
- The battery is low. When the battery is low, you will hear warning signals and the battery symbol on the display will blink.

2.3. Base Station Rear

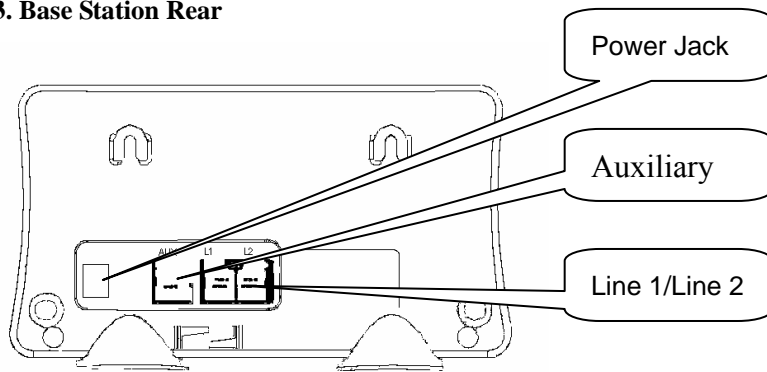

NOTE: Aux input is connected to line 1 and can be used to connect a modem, fax, or ordinary handset type phone. If the Aux input is using line 1, then line 1 will not be available to the system until the Aux call has ended.

Plug one end of the adapter into the power outlet and the other end into the adapter jack on the bottom of the base.



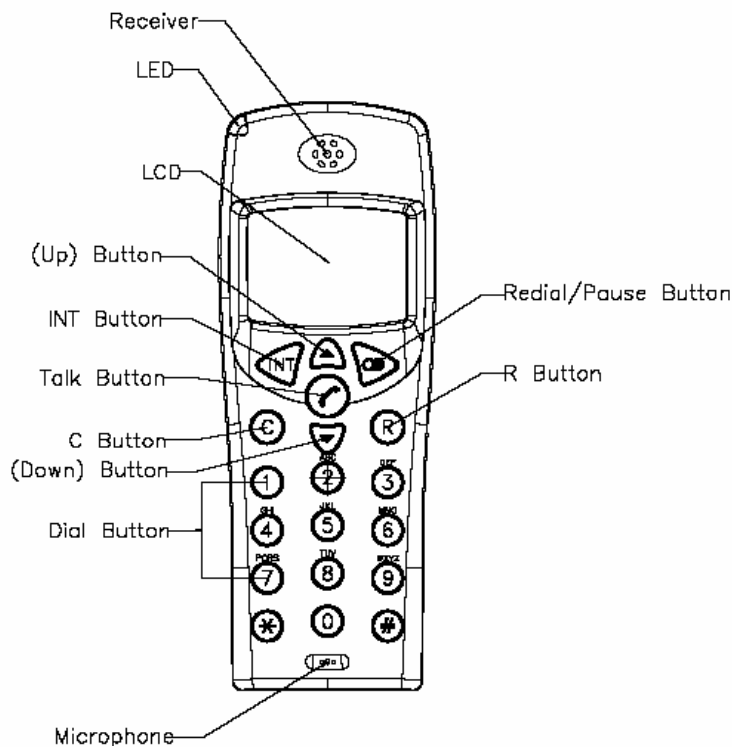

Connect one end of the telephone cord with the analogue (PSTN) phone jack (RJ11) and the other end to the back of the DECT PABX station into the Line 1 jack.

Do the same for Line 2.

2.4. Handset Controls



2.5. Handset Key / LCD displays brief overview :

	OK / Intercom		Redial
	Phone book		Menu Select
	Talk		Signal Strength
	On / Off / Flash / Recall		Mute / Delete / Cancel
	Missed Call		Ringer Off
	Battery		Mute
	Baby call/Hot Call		Speaker Phone
	Menu		*Line Busy Indication



* The icon “L1” or “L2” appears in all handsets when one of the external line is connected. When both lines are in use, ”12” appears on the display.

2.6. Using the Menu:

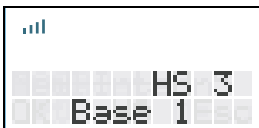
The phone is menu driven.



To enter the Menu, press the Menu key ( **Down key**) and confirm selection with **OK** key.

You are now able to scroll through the menu by using the **Up** and **Down** Key  

OK  key is often used to confirm a setting or to enter a sub menu.

The  button (**Erase key**) is often used to return to a previous menu or to abort the operation.



Press the  button for 2 seconds to return to stand by mode.







2.7. Handset Display Language



You can select one of four different display languages. They are English, German, Italian and French.

- Press **Menu**  key when the handset is in standby mode..

- Select **HS SETTING** by using the **UP** and **DOWN** keys  .

- Press **OK key**  to confirm.
- Select **LANGUAGE** by using the **UP** and **DOWN** keys  .
- Press **OK key**  to confirm.
- Select the desired language by using the **UP** and **DOWN** keys  .
- Press **OK**  to confirm.





3. GETTING STARTED

Before you start working with this DECT System, you need to make some minimum settings to utilize the DECT System functions. Please do these settings first. This handset can then be used as a receptionist handset.

3.1. Ringing Priority (by default, all handsets will ring simultaneously)



On an external call, this priority handset will ring for the pre-programmed ring cycles before the other handsets ring.



- Press **Menu**  key when the handset is in standby mode..
- Select **BS SETTING** by using the **UP** and **DOWN** keys  .
- Press **OK key**  to confirm

Enter Master PIN (Default Master Pin is **1590**)

Press **OK**  key to confirm.

- Select **RING PRIOR** by using the **UP** and **DOWN** keys  .



Press **OK**  key to confirm.

Select **Line 1** or **Line 2** by using **UP** and **DOWN** keys  

Press **OK**  key to confirm.

Select handset **HS NO.** by using **UP** and **DOWN** keys  

Press **OK**  key to confirm.

Select ringer count **RING CNT** by using **UP** and **DOWN** keys  











Press **OK**  key to confirm



3.2. Line Priority For Handsets (default assignment is alternative)



You can set external line access priority and assignment to a handset, the handset can then only use the assigned external line to make external calls. Each handset has choices of Alternative, Line 1 first, Line 2 first, Line 1 only, Line 2 only and No (**No access to external line**)

This external line priority has no effect on receiving incoming calls.

- Press **MENU**  key when the unit is in standby mode.
- Select **BS SETTING** by using the **UP** and **DOWN** keys   and press **OK** key .
- Enter the Base Pin code **MASTER PIN (Default is 1590)**
- Press **OK** key  to confirm.
- Select **SELECT LINE** by using the **UP** and **DOWN** keys  .
- Press **OK**  to confirm.
- Select the desired handset by using the **UP** and **DOWN** keys  . (**HS1 =HANDSET 1**)
- Press **OK**  to confirm.

Select **the desired priority** by using the **UP** and **DOWN** keys  .

- Press **OK**  to confirm.-





3.3. Handset Group

You can set a group of handsets to ring and answer the assigned external line when an incoming external call is on the line.



Please note: When a handset is assigned by Ringing Priority to ring on the restricted line, it always completes Ringing Priority first.





To assign a handset to only ring and answer a designated external line,

- Press **MENU**  key when the handset is in standby mode.
- Select **BS SETTING** by using the **UP** and **DOWN** keys   and press **OK**  key
- Enter the Base Pin code **MASTER PIN (Default is 1590)**

- Press **OK key**  to confirm.

- Select **RING GROUP** by using the **UP** and **DOWN** keys  .

Press **OK key**  to confirm.

Select the desired external line by using **UP** and **DOWN** keys  .

Press **OK key**  to confirm.

Select the handset **not to ring** by pressing a number from 1 to 9 (1 = handset No. 1). The selected handset number will appear as “X”.

Press **DOWN**  key for handset No.10 to No.15. Ex., press 0 for handset No.10 and press 2 for handset No. 12. The selected handset number will appear as “X”.

Press **OK key**  to confirm.

NOTE! The handsets selected as above (marked by X), are the handsets that WILL NOT RING in the group(s)

4. HANDSET OPERATION

4.1. Switching the Handset On / Off :

To switch off the handset, press and hold the Line button for 2 seconds in the standby mode.

To switch on the handset press and hold the Line button again for 2 seconds.

When the handset is switched off, no calls can be made or received.

4.2. Making an external call

4.2.1. Direct Call

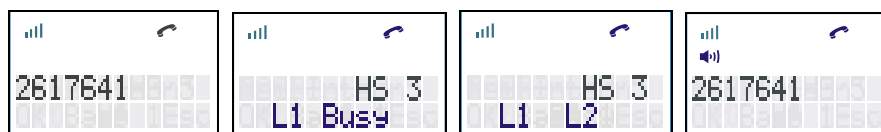



• Press the Line  button, you will hear the external dial tone.

• Enter the telephone number and wait for connection

• “ **L1 Busy** ” = **L1 Line in use**

• “ **L1 L2** ” = **Both lines in use**

• Press the Line button  During conversation, for a minimum of 2 seconds. You can now make the

conversation handsfree via the built-in speaker and microphone. 

Press the Line button again for 2 seconds to stop the hands free mode or press the line key for a short duration to disconnect the call

4.2.2. Pre- dialing

- Enter the telephone number. If needed, you can erase digits by pressing the Erase button “ C ”.
- Press the Line button . The phone number will be dialed automatically.

4.3. Making an Internal Call

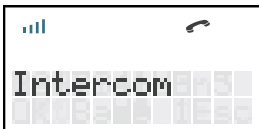

If you have more than one handset subscribed to the PABX, you can make an internal call between the Handsets

- Press **OK / INTERCOM**  key
- Press a handset No. The called handset will ring
- Press ‘line key’ on the called handset and start talking

4.4. Answering an Incoming Phone Call

When there is an external incoming call, the telephone number is displayed if sent by the network.

When the incoming call is an internal call, the display shows the calling handset No.

When it is an external call and the number is not transferred (private call), ‘**EXTERNAL**’ is displayed.

4.4.1. Answering Call

To answer an incoming call, press the LINE button.

4.4.2. Transferring a Call to Another Handset

You can transfer an internal or external call to another handset.

Press **Line key**  to answer the call.

Press **OK/INTERCOM**  key and then a handset No.

Press Line key  again to disconnect the call and transfer the call to the handset

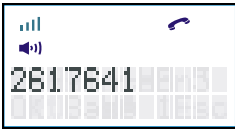

The call has now been transferred.

4.4.3 Making a Hands Free Phone Call





With the Aristel DC209 handset you can make handsfree phone calls.

Press the Line button , during conversation, for minimum 2 seconds. You can now make the conversation handsfree via the built-in speaker and microphone.

Press the Line button  again for 2 seconds to stop the hands free mode or press the line key  for less than 1 second to disconnect the call.

4.5. Changing the Speaker Volume



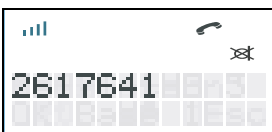

The volume of the speaker can be changed by using the **Up** and **Down** Key   during conversation. The volume can be changed in 10 levels.

4.6. Deactivating the Microphone (Mute)





It is possible to mute the microphone during a conversation:

- Press C button  to mute the microphone, Mute indicator appears on display.
- Press C button  again to activate the microphone. Mute indicator will disappear.

4.7. Last Number Redial

The DECT PABX handset saves the three last dialed telephone numbers in the redial memory.

- You can enter the Redial list by pushing **REDIAL**  key in the stand-by mode.
- Scroll through the Redial memory by pushing **REDIAL**  key.
- When the desired number appears on the display, press the Line button.
- The number will be dialed automatically.

Press the  button for 2 seconds to escape the redial list if you don't want to make a call from the list.



4.8. Calling a Number Out of the Caller List

The DECT PABX handset saves the telephone numbers of the last 10 external incoming calls in the caller list. This is only done when the telephone number of the incoming call has been sent via the analogue network.



Press **MENU** key  when the handset is in standby mode.

Select **CALLER ID** by using the **UP** and **DOWN** keys   and press **OK**  key

- Scroll through the Caller List by using the **UP** and **DOWN** keys  .
- When the desired number appears on the display, press the **LINE** button .
- The number will be dialed automatically.

5. Call Transfer, On Hold, Toggle and Three Party Conference

5.1. Call on Hold

To put a call on hold during conversation, press **OK/INTERCOM** key .

If you want to retrieve the call on hold, press **OK/INTERCOM** key  again.

If you press Line key after external call on hold, the external call will call back.

5.2. Transfer External Call to Another Handset

Make a call or after receiving an incoming call, press **OK/INTERCOM**  key.

Enter the internal handset No. and press Line button  to transfer the external call.

You will be disconnected but both other parties can talk together.

5.3. Alternate Call (Toggling between an internal call and an external call)

If you place an external call on hold, you can make a call to another internal handset. You can then toggle between the first and the second call.

Put the external call on hold by pressing **OK/INTERCOM** key .

Enter the called internal handset No., when the call is connected, press **OK/INTERCOM**  key (Toggle) to switch between both calls. One call will be placed on hold and you can talk to the other caller.

Note: If you press the Line button, you will be disconnected and the other handset will be talking to the external caller alone.

5.4. Three Party Conference Call

You can establish a three party conference with another internal caller and an external caller.

Put the external call on hold by pressing **OK/INTERCOM**  key.







Enter the called internal handset No., when the call is connected, press “#” button for **2 sec** to establish three party conference. Both handsets will start counting the talking time.

Note: If during the conference call you want to talk to only the internal caller, press **OK/INTERCOM**  key. External call will be placed on hold. You can Toggle or restart conference at any time.

5.5. Handling Two External Calls Simultaneously Using One Handset

You handle two external calls simultaneously using one handset.

If a second external call comes in while you are talking to the first external caller,

- Put the first external caller on hold by pressing **OK/INTERCOM** key .
- Press **Line** button  once to let the second caller ring on your handset.
- Once it rings, press **Line** button  again to pick up the second caller.
- Press **OK/INTERCOM**  again to put the second caller on hold and press **Line**  button.
- The previously on-hold first caller will ring your handset.
- Press **Line** button  to resume conversation with the first caller.

While talking to the first caller, the 2nd caller is on-hold. No other handset can access the second caller.

6. PHONEBOOK

6.1. Using the Alphanumeric Keypad



Use the alphanumeric keypad to enter text. To select a letter, press the corresponding button. Eg. if you press numerical button ‘5’, the first character (J) will be displayed. Press it multiple times if you want to select another character under this button. Press button ‘2’ twice to select the letter ‘B’. If you want to select ‘A’ as well as ‘B’, press button ‘A’ first, wait for 2 seconds until the cursor has moved to the next location and select then button ‘B’. Wrongly entered characters can be erased by pressing the **C** button . Press “*” key to show small case letter, e.g., a, b, c







Available Characters: Press the correct buttons to get the following characters:

[1] () —

- [2] A B C a b c ,
- [3] D E F d e f :
- [4] G H I g h I
- [5] J K L j k l %
- [6] M N O m n o /
- [7] P Q R S p q r s
- [8] T U V t u v
- [9] W X Y Z w x y z
- [0] β™ √ ⇐
- [*] change between small and capital letter
- [#] #
- [ DOWN] <space>

6.2. Adding an Entry to the Phonebook



- Press **Menu**  key when the handset is in standby mode.
- Select **PHONE BOOK** by using the **UP** and **DOWN** keys  .
- Press **OK key**  to confirm.
- Select **ADD** by using the **UP** and **DOWN** keys  .







Press **OK key**  to confirm.

Enter the name and press **OK key**  to confirm.



Enter the number and press **OK key**  to confirm.

During adding, press **C** button for 2 seconds to abort.

6.3. Changing a Number and/or Name in Phonebook

- Press **Menu**  key when the unit is in standby mode..
- Select **PHONE BOOK** by using the **UP** and **DOWN** keys  .
- Press **OK key**  to confirm.
- Select **EDIT** by using the **UP** and **DOWN** keys  .

Press **OK key**  to confirm.

Select the name and number to change by using **UP** and **DOWN** keys  .



Press **OK** key  to confirm.

Use **C**  button to erase old entry, enter new number and press **OK** key  to confirm.

During changing, press **C**  button for 2 seconds to abort.

6.4 Reading the Phonebook List

Press **Menu**  key when the handset is in standby mode..

- Select **PHONE BOOK** by using the **UP** and **DOWN** keys  .

- Press **OK** key  to confirm.

- Select **READ** by using the **UP** and **DOWN** keys  .



Press **OK** key  to confirm.

Scroll the phonebook list by using **UP** and **DOWN** keys  .

Press **C** button  to return to standby mode.

6.5. Erasing One Number and/or Name from the Phonebook



Press **Menu**  key when the handset is in standby mode.



Select **PHONE BOOK** by using the **UP** and **DOWN** keys  .

- Press **OK** key  to confirm.

- Select **DELETE** by using the **UP** and **DOWN** keys  .

Press **OK** key  to confirm.



-Select the phonebook entry to be deleted by using **UP** and **DOWN** keys  .

Press **OK** key  to confirm and then press **OK** key  to confirm again



During the deleting, press **C** button  to abort.



6.6. Erasing All Numbers and/or Names from the Phonebook

- Press **Menu**  key when the handset is in standby mode.

- Select **PHONE BOOK** by using the **UP** and **DOWN** keys  .

- Press **OK** key  to confirm.

- Select **ERASE ALL** by using the **UP** and **DOWN** keys  .





- Press **OK** key  to confirm. And then press **OK** key  to confirm again

- During the deleting, press **C** button  to abort

7. HANDSET SETTINGS

7.1. Key Lock















- Press **MENU**  key when the handset is in standby mode..
- Select **KEY LOCK** by using the **UP** and **DOWN** keys  .
- Press **OK** key  to confirm

The display shows “**LOCKED**”. The keypad is now locked.

After press **DOWN**  key and **OK** key , the keypad will be released.



7.2. Selecting the Ringer Melody and Volume for External Calls













- Press **MENU**  key when the handset is in standby mode..
- Select **HS SETTING** by using the **UP** and **DOWN** keys  .
- Press **OK**  to confirm.
- Select **SET EXTRING/MELODY EXT** by using the **UP** and **DOWN** keys  .
- Press **OK**  to confirm.
- Select the desired ringer melody by using the **UP** and **DOWN** keys  .
- Press **OK**  to confirm.
- Select the desired ringer volume by using the **UP** and **DOWN** keys  .
- Press **OK**  to confirm.

7.3. Selecting the Ringer Melody and Volume for Internal Calls











- Press **MENU**  key when the handset is in standby mode..
- Select **HS SETTING** by using the **UP** and **DOWN** keys  .

- Press **OK**  to confirm.
- Select **SET INTRING/MELODY INT** by using the **UP** and **DOWN** keys  .
- Press **OK**  to confirm.
- Select the desired ringer melody by using the **UP** and **DOWN** keys  .
- Press **OK**  to confirm.
- Select the desired ringer volume by using the **UP** and **DOWN** keys  .
- Press **OK**  to confirm.

7.4. HOT CALL/Baby Call Function *Note: Baby/Hot Call function cannot be used in handsfree mode.*













If you enable this function, the programmed number will be dialed automatically when any key is pressed. All other functions of the keypad will be disabled until Baby Call has been cancelled.

- Press **MENU**  key when the handset is in standby mode..
- Select **HS SETTING** by using the **UP** and **DOWN** keys  .
- Press **OK**  to confirm.
- Select **HOT CALL/BABY CALL** by using the **UP** and **DOWN** keys  .
- Press **OK**  to confirm.
- Enter baby call telephone number using numeric key pad.
- Press **OK** key  to confirm. The display will show BABY CALL.
- Press **DOWN** key  **twice** quickly to disable baby call.

7.5. Enable/Disable Key Tone











- Press **MENU**  key when the handset is in standby mode..
- Select **HS SETTING** by using the **UP** and **DOWN** keys  .
- Press **OK**  to confirm.
- Select **SET KEYTONE** by using the **UP** and **DOWN** keys  .

- Press **OK**  to confirm.
- Select **ON/OFF** by using the **UP** and **DOWN** keys   .
- Press **OK**  to confirm

7.6. Naming a Handset









The name of the handset will be displayed in standby mode. If you want to enter or change this name:

- Press **MENU**  key when the handset is in standby mode..
- Select **HS SETTING** by using the **UP** and **DOWN** keys   .
- Press **OK**  to confirm.
- Select **USER NAME** by using the **UP** and **DOWN** keys   .
- Press **OK**  to confirm.
- Enter or change the handset name by means of the alphanumerical keypad.
- Press **OK**  to confirm.

7.7. Set PIN Code



To change default handset PIN code.

- Press **MENU**  key when the handset is in standby mode..
- Select **HS SETTING** by using the **UP** and **DOWN** keys   .
- Press **OK**  to confirm.
- Select **SET PINCODE** by using the **UP** and **DOWN** keys   .
- Press **OK**  to confirm.

Enter the Handset Pin code, **HS PIN: (DEFAULT PIN = 1590)**

Press **OK**  to confirm.

- Enter the new Pin code: **NEW PIN**

- Press **OK**  to confirm.

- Re-enter the new Pin code: **RETYPE:**



- Press **OK**  to confirm.

7.8. Auto PICKUP On/Off



When a call comes in, a handset automatically answers the call when it is removed from charger

. Press **MENU**  key when the handset is in standby mode..

- Select **HS SETTING** by using the **UP** and **DOWN** keys  .

- Press **OK**  to confirm.

- Select **AUTO ANSWER/AUTO PICKUP** by using the **UP** and **DOWN** keys  .

- Press **OK**  to confirm.



- Select **ON/OFF** by using the **UP** and **DOWN** keys  .

- Press **OK**  to confirm



7.9. To Answer Call Using Anykey



- Press **MENU** key  when the handset is in standby mode..

- Select **HS SETTING** by using the **UP** and **DOWN** keys  .

- Press **OK**  to confirm.

- Select **ANYKEY TALK** by using the **UP** and **DOWN** keys  .

- Press **OK**  to confirm.



- Select **ON/OFF** by using the **UP** and **DOWN** keys  .



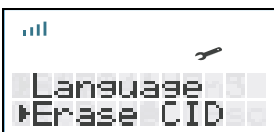



- Press **OK**  to confirm

7.10. Erase Caller List



- Press **MENU** key  when the handset is in standby mode.

- Select **HS SETTING** by using the **UP** and **DOWN** keys  .

- Press **OK**  to confirm.
 - Select **ERASE Caller ID** by using the **UP** and **DOWN** keys  .
 - Press **OK**  to confirm.
 - Prompt **SURE?**
- Press **OK**  to confirm or **C** button  to return

7.11. Handset Reset



The handset default settings are:

Display language: English

Handset Pin: 1590









Redial List: Empty

Call List: Empty

Baby Call: Off

Key Click: On

To reset the handset to its standard settings:

- Press **MENU**  when the handset is in standby mode..
- Select **HS SETTING** by using the **UP** and **DOWN** keys  .
- Press **OK**  to confirm.
- Select **SET DEFAULT** by using the **UP** and **DOWN** keys  .
- Press **OK**  to confirm.
- Enter the Base Pin code **MASTER PIN (Default is 1590)**
- Press **OK**  to confirm.
- The display shows **SURE?**
- Press **OK**  to confirm or **ESC** to leave the setting.

8. Subscribe / Unsubscribe a Handset

8.1. Subscribe a handset to the DECT system

Every new handset must be subscribed onto the base station before you can make a phone call.

The two handsets included with the Aristel DECT PABX are already subscribed.







If you want to subscribe a new handset on the DECT PABX station or when you have unregistered a handset and need to subscribe it again, you must first use any of the already-registered Aristel DECT PABX handsets to grant the new handset registration.

Please Note: Other manufacturer's handsets do not grant Handset registration. Only the already-registered Aristel handsets are able to grant new handset registration.

You will need the **Master PIN**. Default Master **PIN is 1590**

8.1.1.To Allow New Handset Registration



- Press **MENU**  key when the handset is in standby mode.
- Select **BS SETTING** by using the **UP** and **DOWN** keys   and press **OK**  key
- Enter the Base Pin code **MASTER PIN (Default is 1590)**
- Press **OK**  key to confirm.
- Select **NEW HS** by using the **UP** and **DOWN** keys  .

Press **OK**  key to confirm.

Enter the Sub Pin code **SUB PIN (Default is 1590)**

Press **OK**  key to confirm.

Select the desired handset by entering number from 1 to 9 (1 = handset No. 1). Unavailable handset No. is shown as “—“

Press **DOWN**  key for handset No.10 to No.15. Ex., press 0 for No.10 and press 2 for handset No. 12. Unavailable handset No. is shown as “—“

Press **OK**  key to confirm.

Now you have successfully granted New Handset registration and Pre-assign a handset No. (Int. No.) to this new handset.

Proceed with 8.1.2 to register the new handset

8.1.2. To Register a DECT system Handset to the DECT system (see step 8.1.1 first)



If you want to subscribe a new handset on the DECT PABX station or when you have unregistered a

handset and need to subscribe it again, you must first use any of the already-registered Aristel DECT PABX handsets to grant the new handset registration. Step 8.1.1

Press **MENU** key  when the handset is in standby mode.

Select **REGISTER** by using the **UP** and **DOWN** keys  .

Press **OK** key  to confirm

- Select **BASE** by using the **UP** and **DOWN** keys  .

Press **OK** key  to confirm

Wait for 15 seconds till message **XXXXX-XXXXXXX** appears.

Press **OK** key  to confirm

Enter Registration PIN (**Default is 1590**)

Press **OK** key  to confirm

Wait for 5 seconds to complete handset subscription. Display should return to standby mode.

Please note: You only have about two minutes to subscribe a handset after New Handset Registration allowed. You have to repeat the New Handset Registration again if the time expires.

For other DECT handsets with GAP, please consult the manufacturers' user manual for subscription.

8.2. Remove Subscription of a Handset from the DECT system

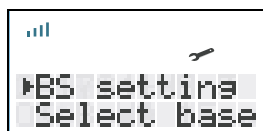



- Press **MENU** key  when the unit is in standby mode.

- Select **BS SETTING** by using the **UP** and **DOWN** keys   and press **OK**  key

- Enter the Base Pin code **MASTER PIN (Default is 1590)**

- Press **OK**  key to confirm.

- Select **REMOVE HS** by using the **UP** and **DOWN** keys  .

Press **OK** key  to confirm.

Press **OK** key  to confirm.

Select the desired handset by pressing number from 1 to 9 (1 = handset No. 1) from available list. Selected handset number will appear "X" The in-use handset is indicated "M" and cannot be removed.

Press **DOWN** key  for handset No.10 to No.15. Ex., press 0 for No.10 and press 2 for handset No. 12. Selected handset number will appear "X"

Press **OK** key  to confirm.

Now you have successfully removed handset registration from the DECT PABX station.

8.3. To Change the Previously Assigned Handset No.



To change the previously assigned handset No., you will have to unsubscribe the handset from the DECT System and re-subscribe the handset with a desired new handset assignment number.

8.4. Selecting a Base Station





If a handset is subscribed to different base stations, the different base set can be selected.

Press **MENU** key  when the handset is in standby mode.

Select **SELECT BASE** by using the **UP** and **DOWN** keys  .

Press **OK** key  to confirm

Select the desired base station or auto search **BASE** by using the **UP** and **DOWN** keys  .
Wait for 10 seconds to complete registration to show standby mode display.

9. BASE SETTINGS

9.1. Dialing Mode (default mode is DTMF dialing)

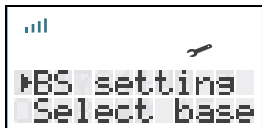

If you select Tone (DTMF) or Rotary (Pulse) dialing mode.



Press **MENU** key  when the handset is in standby mode.

- Select **BS SETTING** by using the **UP** and **DOWN** keys   and press **OK**  key

- Enter the Base Pin code **MASTER PIN (Default is 1590)**

Press **OK** key  to confirm

Select **DIAL MODE**

Select **DTMF** or **Pulse** dialing mode by using **UP** and **DOWN** keys  .

Press **OK** key  to conform.

9.2. Set Recall/Flash Time (default value is 100mSeconds)





You can set Flash time to 100ms, 120ms, 300ms and 600ms.

Press **MENU**  key when the unit is in standby mode.

- Select **BS SETTING** by using the **UP** and **DOWN** keys   and press **OK**  key

- Enter the Base Pin code **MASTER PIN (Default is 1590)**

Press **OK**  key to confirm

Select the desired **RECALL TIME/FLASH** time by using **UP** and **DOWN** keys  .

Press **OK** key  to conform.

9.3. To Set Pause Time (default value is 3 Seconds)





You can set Pause time to 1sec, 2sec, 3sec, 4sec,

Press **MENU**  key when the handset is in standby mode.

- Select **BS SETTING** by using the **UP** and **DOWN** keys   and press **OK**  key

- Enter the Base Pin code **MASTER PIN (Default is 1590)**

Press **OK**  key to confirm

Select the desired **PAUSE** time by using **UP** and **DOWN** keys  .

Press **OK**  key to conform.

9.4. Call Barring





You can program up to five different call barring codes, and assign one of the call barring codes to any handset.

Press **MENU** key  when the handset is in standby mode.



Select **BS SETTING** by using the **UP** and **DOWN** keys   and press **OK** key 

- Enter the Base Pin code **MASTER PIN (Default is 1590)**

Press **OK** key  to confirm

Select **CALL BARRING** by using **UP** and **DOWN** keys  .

- Press **OK** key  to conform.

Select the desired number by using **UP** and **DOWN** keys   and enter the desired blocked number, e.g., **0, 00**.

- Press **OK** key  to confirm

Select the desired handset by pressing number from 1 to 9 (1 = handset No. 1). Selected handset number will replace “**X**”

Press **OK** key  to confirm.

Repeat the steps above for different blocked number or handset.

To deactivate call barring,

Repeat the steps above till,

Select the desired handset by pressing number from 1 to 9 (1 = handset No. 1). Handset number will appear “**X**” on display.

Press **OK** key  to confirm.

9.5. Least Cost Route



LCR can be programmed for:- **service provider** (digits to be inserted), **Code** (override code), **PABX code** (O/G access) and **Router** (On/Off).

Press **MENU** key  when the handset is in standby mode.

Select **BS SETTING** by using the **UP** and **DOWN** keys   and press **OK** key .

- Enter the Base Pin code **MASTER PIN (Default is 1590)**

Press **OK** key  to confirm

Select **LCR SETTING** by using **UP** and **DOWN** keys  .

Press **OK** key  to conform.

Select the desired LCR by using **UP** and **DOWN** keys  .

Press **OK** key  to conform.

Enter LCR number , Press **OK** key  to conform.

9.6. Change PIN Code



You can change Pin code. Pin code is minimum four digits and maximum eight digits.

Press **MENU** key  when the unit is in standby mode.

Select **BS SETTING** by using the **UP-** and **DOWN** keys   and press **OK** key 

- Enter the Base Pin code **MASTER PIN (Default is 1590)**

Press **OK** key  to confirm

Select **CHANGE PIN** by using **UP** and **DOWN** keys  .

- Press **OK** key  to conform.

- Enter new Pin code and press **OK** key  to confirm.

- Re-type new Pin code and press **OK** key  to confirm.

9.7 Reset Base Station Settings



- Press **OK** key  to conform.

Default Settings:

Dialing mode: DTMF

Flash time : 100 ms

Pause time: 3 sec

Line Selection: Alternate

Ringer Priority : off

Call Barring : off

10. TECHNICAL DATA

- Standard: DECT (**D**igital **E**nhanced **C**ordless **T**elecommunications) GAP (**G**eneric **A**ccess **P**rofile)
- Frequency range: 1880 ~ 1900 MHz (BW=20MHz); 1920 ~ 1940 MHz (BW=20MHz)
- RF channels: 10 channels
- Channel Bandwidth: 1.728
- Modulation: GFSK
- Transmission Output Power: 10mW
- Antenna diversity supported Base Station
- Data Transmission Rate: 1.152 Mbps
- Speech coding: ADPCM 32 K bps
- Communication Range (max.): Outdoor 300 Metres - Indoor 50 Metres
- Power Supply:
 - Base Station Adapter: INPUT AC110 / 230 VAC 60Hz / 50Hz
OUTPUT DC 9V 350mA
 - Charger Adapter: INPUT AC110 / 230 VAC 60Hz / 50Hz
OUTPUT DC 7,5V 210mA
- Handset: Ni-Mh Rechargeable Battery 1,2V AAA*3
- Operating Time: Standby 100 Hours - Talk: 10 Hours
- Operating Temperature: 0°C to 40°C
- Storage Temperature: 0°C to 40°C
- Dimensions: Handset: 135 x 51 x 29 m/m L/W/D
- Base Station: 179 x 141 x 42 m/m L/W/D
- Charger: 80 x 60 x 110 m/m L/W/D
- Weight: Handset: 150g (approx.)
- Base station: 400g (approx.)
- Charger: 80g (approx.)